



NC-Rotary Table

D01 NC-Rotary Table



VNCM-150 ~ 400L / R

D03 NC-Rotary Table



VNCM-150R

D03 NC-Rotary Table

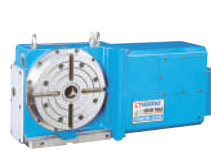

VNCM-220R

D03 NC-Rotary Table



VNCM-250R

D03 NC-Rotary Table

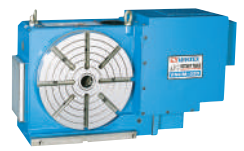

VNCM-320R

D03 NC-Rotary Table



VNCM-400R

D04 NC-Rotary Table



VNCX-10

D06 Tailstock For NC Rotary Table



TS-135 ~ 210 / 135 ~ 210-MT3

D06 Tailstock For NC Rotary Table



TS-135 ~ 210 / 135 ~ 210-MT3

MC Power Vise

D07 MC Power Vise



VQC-100

D07 MC Power Vise



VQC-160

D07 MC Power Vise



EXP.

VQC-125FJL

D07 MC Power vise



EXP.

VQC-125MJL

D07 MC Power Vise



VQCV-125 / 160H-L/R

D07 NC Hydro Machine Vices

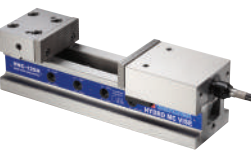

VNC

D07 Convenient Type Machine Vise

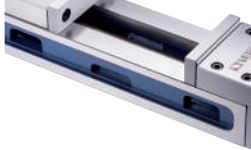

VCM-47

D07 Precision Pneumatic Ang-Fixed Power Vise



VMC-

D07 Precision MC Power Vise



VMC-

D07 Precision Compact MC Vise



VMC-

Base Plate

D09 Base Plate Series

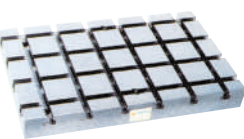

TBP-6040 ~ 10050D

D09 Base Plate Series

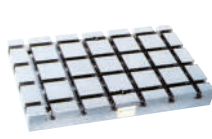

TBP-6040 ~ 10050D

D09 Base Plate Series

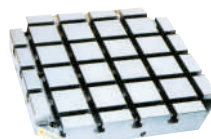

SBP-4040 ~ 8080A

D09 Base Plate Series

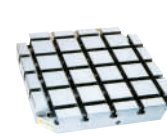

SBP-4040 ~ 8080A

D09 Base Plate Series

NEW

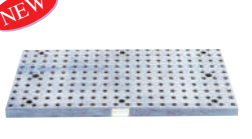

HBP-4060 ~ 50100T

Angle Plate

D10 M/C Angle Plate 90°



BP20-30, 40, 50, 60, 80

D10 M/C Angle Plate 90°



BP22-30 ~ 860

D11 M/C Clamping Cube



BP07-10, 20, 30, 40

D12 Angular Hollow Block 45°

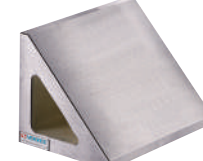

BC45-15, 30, 151, 301

D12 Angular Hollow Block 30°

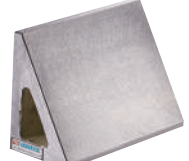

BC30-15, 30, 151, 301

Vice

D13 Flexible Line Up Vice

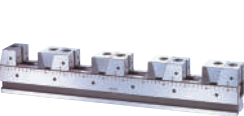

VFS-5030 ~ 7270

D14 Flexible Line Up Vice

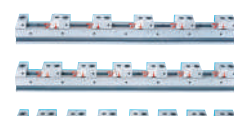

VFS-5030 ~ 7270

D15 Flexible Line Up Vice

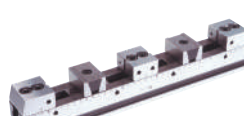

VFL-5030 ~ 7270

D16 Flexible Line Up Vice

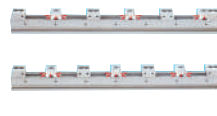

VFL-5030 ~ 7270

D17 Flexible Line Up Vice

NEW



VFN-6030 ~ 8580

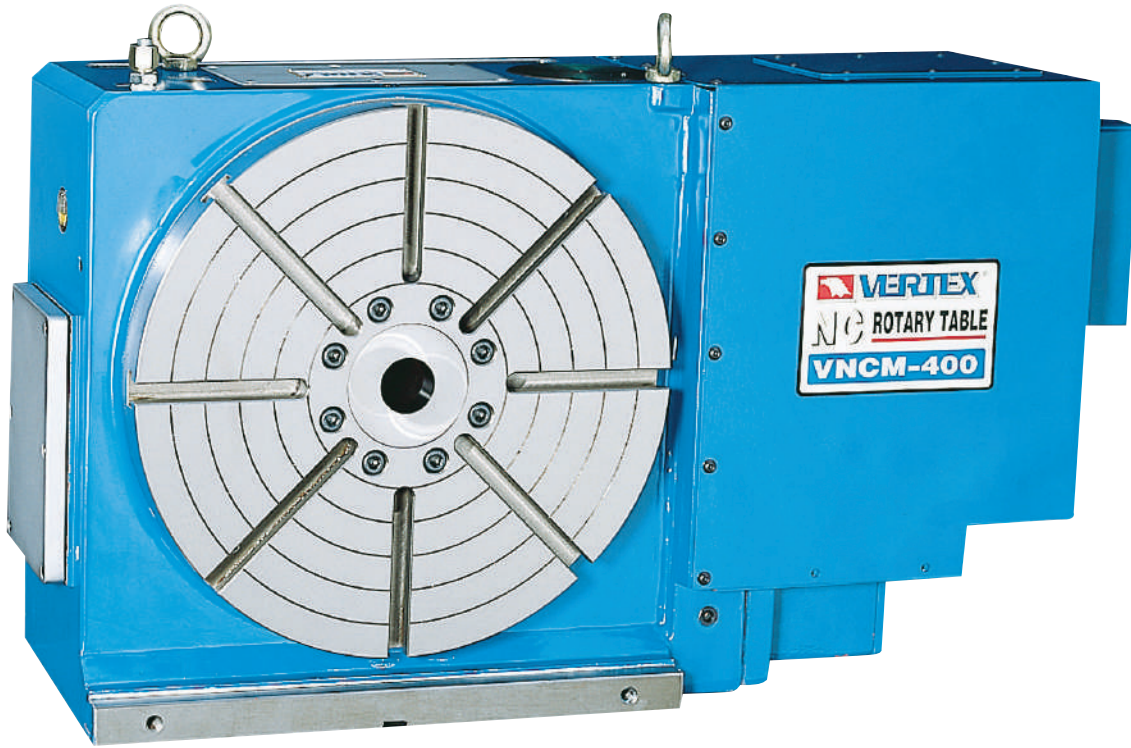

## ● HIGH ACCURACY AND HIGH RIGIDITY

Adoption of new double-lead worm gear--engagement between worm wheel and worm shaft has been improved, and tooth profile has been modified--has contributed greatly to increased dynamic accuracy. To remove the defect of single-lead worm gear. Close-tolerance taper roller bearing assembly is used, and the rotating slide part is finished in a super precision manner, which in turn, implements highly improved overall accuracy.

## ● SLEEVE TYPE CLAMPING MECHANISM

with this system, the Rotary Table is clamped by applying hydraulic pressure to the outer circumference of the turn table. Since the sleeve is positioned closest to the workpiece, the table clamp force is enlarged. This system is not only advantageous for heavy duty cutting but also helps improve the machining accuracy and extend the service life of the Rotary Table.

- This rotary table has been specifically developed to fulfill the requirements of a fully automatic machining process in association with a machine tool. They are used for milling, grinding and drilling of spindles, slots, plannes or bores in the radial or axial direction of the workpiece.
- Can be equipped with stepping motor or DC/AC servo motors.
- Carefully designed, rigid construction to assure high and constant indexing accuracy.
- Can operate as function M or as 4th axis or more, in machining units or numerically controlled machines, and are equally capable of being fitted to any other type of non-NC machine-tools.
- Hardened and ground steel worm, mounted on high precision combined radial-axial bearings.
- Worm mounted on an axial support system, which allows adjustment and suppression of any backlash existing between the worm and the worm-wheel after long-time service.
- High precision  
Axial and radial runout within 0.01mm, Cumulative indexing accuracy within 15 sec.

※ COLOR MAY VARY

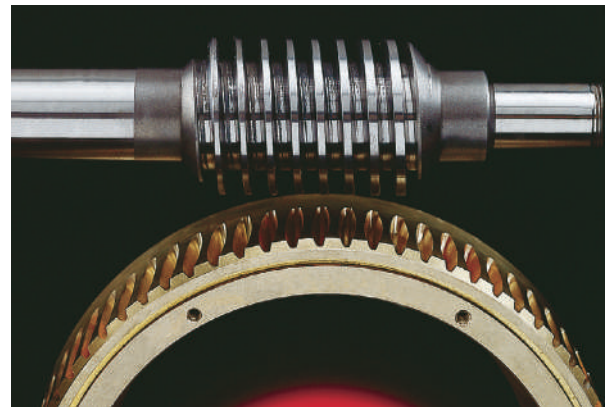

## DOUBLE LEAD WORM GEARS SYSTEM

- New design/special material



## PROGRAMMABLE SERVO MOTOR CONTROLLER



## ● SPECIFICATIONS

ORDER NO.	VNCM-150 $\frac{L}{R}$	VNCM-220 $\frac{L}{R}$	VNCM-250 $\frac{L}{R}$	VNCM-320 $\frac{L}{R}$	VNCM-400 $\frac{L}{R}$
Right-hand type	O	O	O	O	O
Left-hand type	O	O	O	O	O
Turntable diameter	Ø160	Ø225	Ø250	Ø320	Ø400
Table height(Horizontal pos.)	150	165	165	220	250
Table center height(Vertical pos.)	135	160	160	210	255
Center bore diameter	Ø35H7	Ø40H7	Ø40H7	Ø40H7	Ø40H7
T-slot size	12H7	12H7	12H7	14H7	14H7
Guide-block size	14h7	14h7	14h7	18h7	18h7
Number of worm wheel teeth	72	72	72	72	72
Servo motor type	FANUC $\alpha$ 3	FANUC $\alpha$ 6	FANUC $\alpha$ 6	FANUC $\alpha$ 12   FANUC $\alpha$ 6	FANUC $\alpha$ 12
Speed reduction ratio	1/90	1/180	1/180	1/180   1/360	1/180
Table graduation angle per 1 pulse	0.001°	0.001°	0.001°	0.001°	0.001°
Table rotation speed	22.2r.p.m./ (Motor 2,000r.p.m.)	11.1r.p.m./ (Motor 2,000r.p.m.)	11.1r.p.m./ (Motor 2,000r.p.m.)	11.1r.p.m./ (Motor 2,000r.p.m.)   5.5r.p.m./ (Motor 2,000r.p.m.)	11.1r.p.m./ (Motor 2,000r.p.m.)
Clamp method & Clamp torque (kg-m)	8/ (Air 5kg/cm <sup>2</sup> )	50/ (Hydraulic 35kg/cm <sup>2</sup> )	50/ (Hydraulic 35kg/cm <sup>2</sup> )	85/ (Hydraulic 35kg/cm <sup>2</sup> )	180/ (Hydraulic 35kg/cm <sup>2</sup> )
Load capacity, horizontal(kg)	150	250	250	350	500
Load capacity, vertical(kg)	75	100	100	150	200
Inertia force (kg-cm-sec <sup>2</sup> )	4.3	12.3	12.3	38.5	99.8
Max.torque capacity of worm gear (kg-m)	15	48	48	78	170
Max. workpiece diameter	160	225	225	320	400
Cumulative indexing accuracy sec.	20"	15"	15"	15"	15"
Repeatability sec.	4"	4"	4"	4"	4"
Inertia force(convert into motor shaft) kg-cm-sec <sup>2</sup> X10 <sup>-2</sup>	0.2	0.24	0.34	1.85   1.35	1.94
Net weight (kg)	55	75	75	200	300
CODE NO.	4001-001	4001-002	4001-003	4001-004	4001-005

● Other makers' servo motors can be installed.

## ● ACCURACY STANDARD

Unit:mm

NO.	Inspection Item	Inspection Item
1	Table top flatness (concave)	Per overall length 0.01
2	Table top runout	0.015
3	Parallelism of table top and frame bottom	Per overall length 0.02
4	Table spindle center runout	0.01
5	Center bore runout	Hole end 0.01 Per 100mm 0.01
6	Perpendicularity of table top to frame bottom	Per overall length 0.02
7	Perpendicularity of table top to frame bottom guide block	Per overall length 0.02
8	Cumulative indexing accuracy	15"
9	Parallelism of center line between headstock and tailstock to frame bottom guide block	Per 300mm 0.02
10	Height difference of both center lines of headstock (Tailstock center line should be higher)	0.02

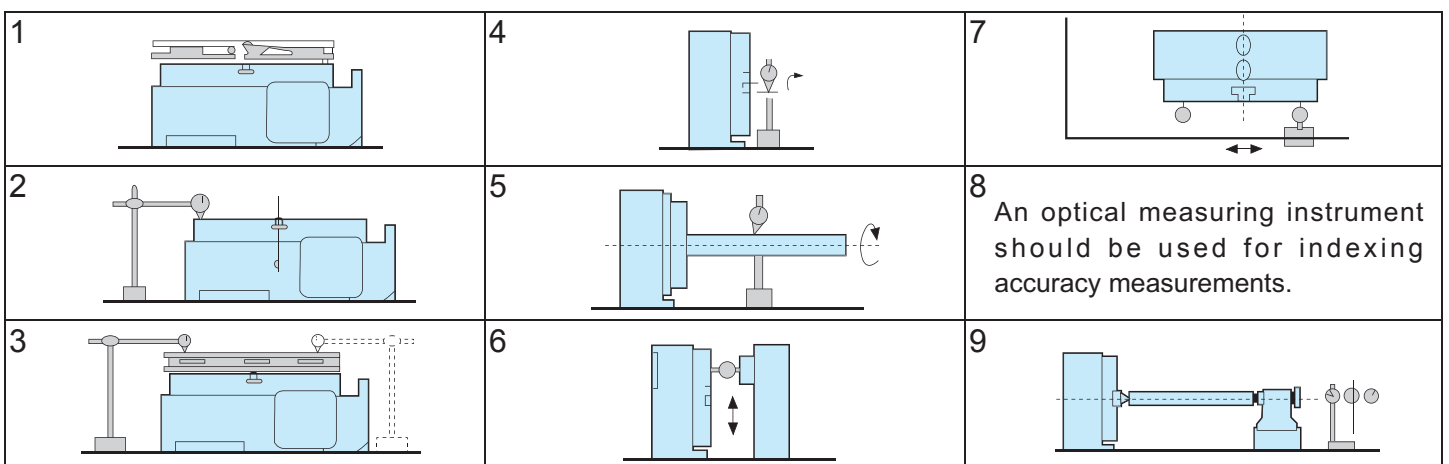





# NC-Rotary Table

ORDER NO.VNCX-10 CODE NO.4001-010



- Motor case setted on the back of the body, increased the space for moving forward and backward, suitable for large or small NC machine using.
- Use of precision lead worm gear assures highly accurate dividing independently of table rotating direction. Further, no backlash will be produced.
- Wide range of machining is accomplished by connecting the Drive Table with Mcode of machining center.
- When used with machining center, the Drive Table will widen the range of applications; circular cutting dividing into equal parts, dividing into unequal parts, lead cutting, can cutting etc.
- MACHINE ZERO AND WORK ZERO. Zero Return Function to either Zero.
- BACKLASH COMPENSATION.
- BUILT-IN PNEUMATIC BRAKE FUNCTION.

## Dimensions

Unit:mm

Item		Unit:mm
Table diameter	250	
Table height	315	
Center height	160	
Center hole diameter	32	
Table reference groove width	14	
Key way	18	
Clamping force(kgf-m)	Penumatic	20
Allowable work diameter	250	
Allowable weight	Horizontal setup Vertical setup	200 100
Allowable work inertia(kgf-cm sec <sup>2</sup> )	12.5	
Total reduction ratio	1:90	
Rotary speed(rpm)	11.1	
Allowable machine torque(kgf-m)	48	

## ACCURACY STANDARD

Unit:mm

NO	Inspection Itme		Tolerance
1	Table top flatness(concave)	Per overall length	0.01
2	Table top runout		0.015
3	Parallelism of table top and frame bottom	Per overall length	0.02
4	Table spindle center runout		0.01
5	Center bore runout	Hole end Per 100mm	0.01 0.01
6	Perpendicularity of table top to frame bottom	Per overall length	0.02
7	Perpendicularity of table top to frame bottom guide block	Per overall length	0.02
8	Cumulative indexing accuracy		15"
9	Parallelism of center line between headstock and tailstok to frame bottom guide block	Per 300mm	0.02
10	Height difference of both headstock and tailstock center lines(Tailstock center line should be higher)		0.02

## VNCX-10

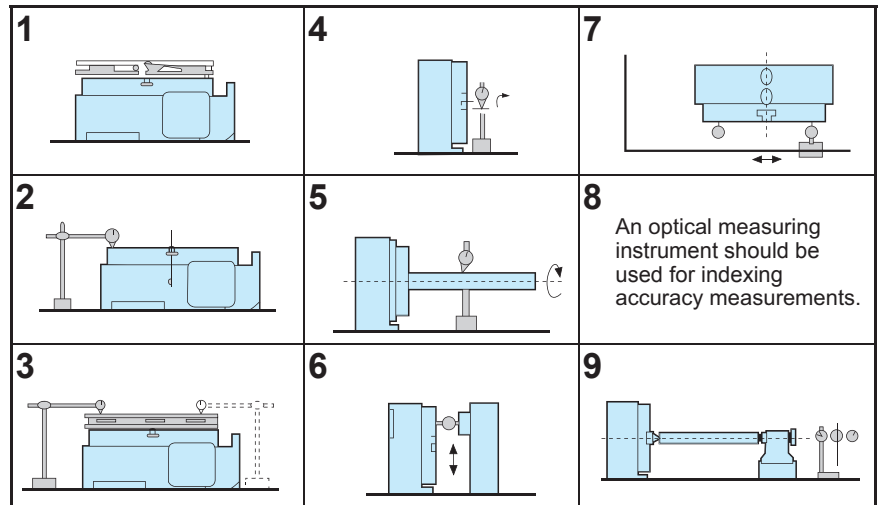
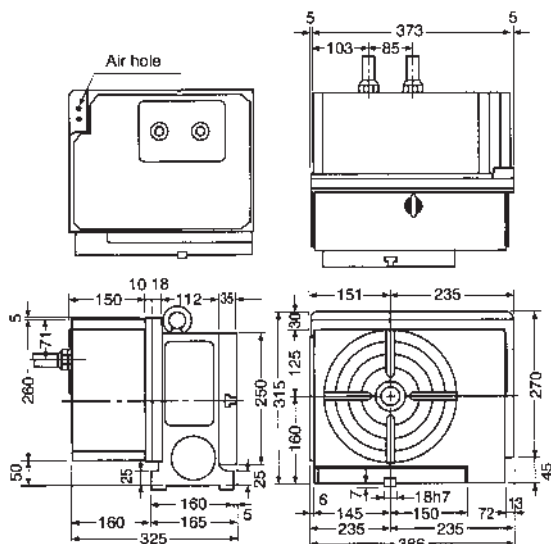



# Tailstock For NC Rotary Table

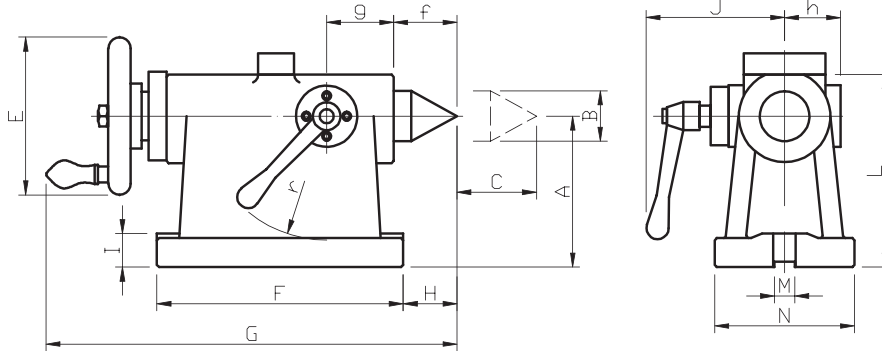
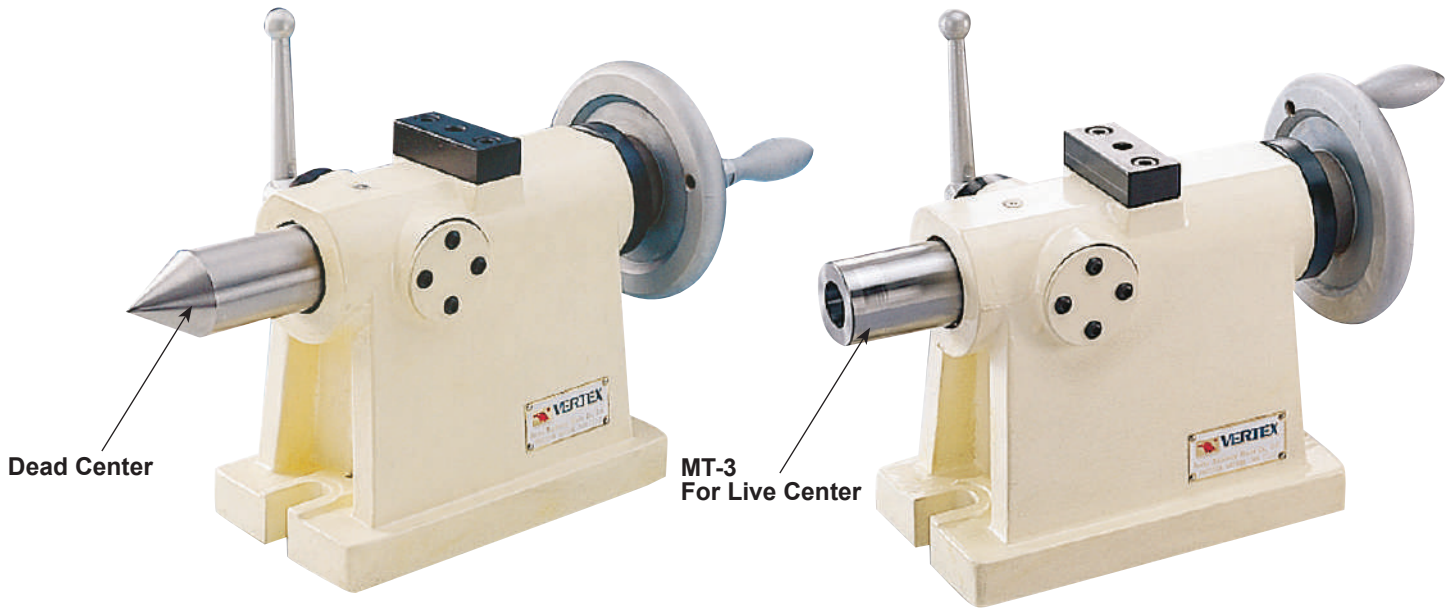

Unit:mm

Main dimension		Center height A	Center diameter B	Storke C	pointed end diameter D	Handle diameter E	Base dimensions FXM	G	H	I	J	K	L
ORDER NO.	For												
TS-135	VNCM-150	135	ø45 MT#3	55	ø14	125	215x120	332	25	25	109	-	164
TS-135-MT3													
TS-160	VNCM-220 VNCX-10 VNCM-250	160	ø45 MT#3		ø18	140	230x130	356	30	30	129	53	193
TS-160-MT3													
TS-210	VNCM-320	210					230x146						243
TS-210-MT3													

Unit:mm

Main dimension		Guide-block size M	c	u	f	g	h	j	r	Net weight (kgs)	CODE NO.						
ORDER NO.	For																
TS-135	VNCM-150	18	42	19	40	69	44	70	80	20.6	4002-001						
TS-135-MT3			46								4002-001A						
TS-160			49	4002-002													
TS-160-MT3	51		4002-002A														
TS-210	VNCM-320		51	19							45	70	52	80	95	29.4	4002-003
TS-210-MT3			57														23

Listed in the above table are examples of applicable models. Those not listed above should be selected so that the center height of the rotary table and dividing heads is the same as that of the tailstock.



**4005~SERIES**

PLEASE SEE A SYSTEM FORM PAGE A SERIES

VQC-160



VQC-160H



VQC-160LC



VQC-160HC



VMC-160HV



VMC-160M



VMC-4L



VNC-125H



VNC-6AD



VMC-6P



VMC-6PD

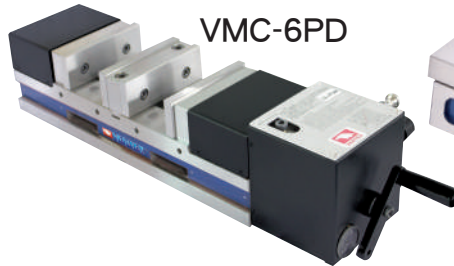

VCV-4D



CC-12



VQCV-125H-L

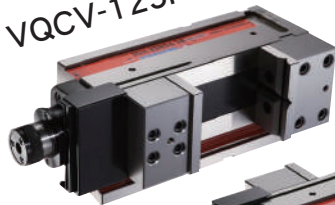

VUT-12



VQCV-125H-R

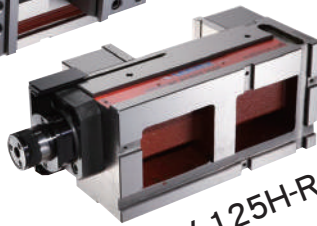

VCV-0611



VMC-6



VUT-300

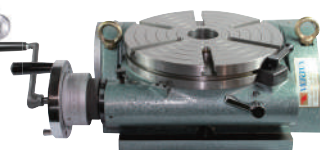

VIT-450



MC POWER VISE

**SAME HEIGHT GUARANTEE**



**TOGGLE JOINT MECHANISM DESIGN FOR HEAVY DUTY WORKING**

### Features

- Compact design. Great clamping capacity & rigid.
- "Toggle joint mechanism". Provides a steady clamping force against shocks and vibrations during the operations, since it clamps the workpiece resiliently with an aid of the "disc-springs" mounted inside.
- Strong clamping force.
- Large jaw stroke range.
- Exclusive Power Vise provide same height same position for horizontal MC, NC, Machine.
- Body is made of FCD60 high quality ductile cast iron, resists deflection or bending.
- Sliding bed ways flame hardened and ground.
- Concealed spindle for protection against chips and dirt.
- Quick of clamping & locking and easy of operation.

### INSPECTION SPECIFICATION

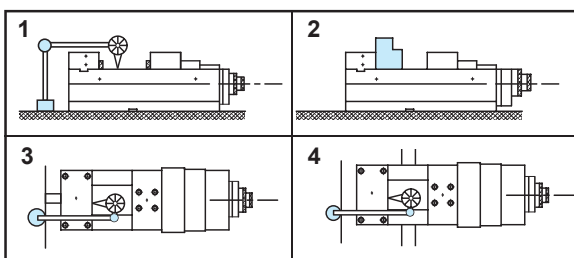

NO.	Inspection Item	Per (100mm)	Guaranteed
1	Parallelism: table face to bottom of bed.		0.01/100mm
2	Squareness :between table face and jaw plate.		0.02/100mm
3	Squareness: keways on bottom of table face to jaw plate.		0.02/100mm
4	Parallelism: table face of the table face block to bottom of bed.		0.02/100mm

### CLAMPING CAPACITY

ORDER NO.	JAW J	JAW Open C	B	MAX. Clamping Force (KN)	G.W. kg
VQC-100	35	128	120	30	26.2
VQC-125	40	205	140	40	40.4
VQC-160	45	275	165	60	72.3
VQC-160L	45	355	165	60	78.6
VQC-200L	70	405	190	60	108

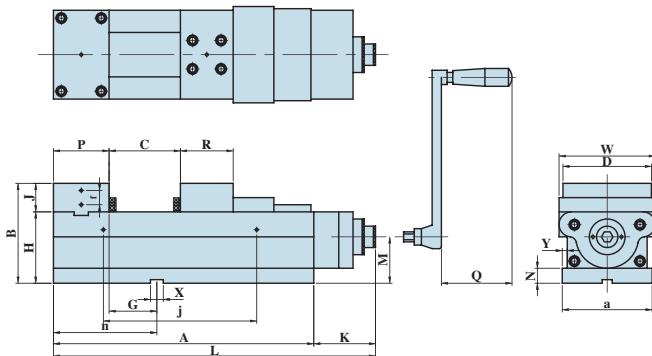

ORDER NO.	A	B	a	D	P	R	G	H	J	K	L
VQC-100	273	120	105	99	73	64	39	85	35	82.5	356.5
VQC-125	364	140	126	124.5	78	74	59	100	40	86	452
VQC-160	456	165	161	159.5	86	86	58	120	45	98	554
VQC-160L	536	165	162	160	86	86	58	120	45	98	634
VQC-200L	616	180	202	200	102	98	74	120	70	95	711

ORDER NO.	M	N	Q	W	X	Y	C OPEN	f	j	n	CODE NO.
VQC-100	50	15	74	110	14	6.5	128	20	105	112	4005-004
VQC-125	65	21	74	135	18	7	205	20	215	139	4005-005
VQC-160	78	21	94	170	18	7	275	20	286	145	4005-006
VQC-160L	78	21	94	174	18	7	355	20	286	145	4005-007
VQC-200L	75	21	96	217	18	7	405	20	386	177	4005-008





- ADJUSTING METHOD**
1. FIXED COLLAR
  2. TURN BY WENCH TO GET NO. 0, 1, 2, 3, 4. TO HAVE CLAMPING FORCE
  3. NO.2 IS MOST SUIT FOR WORKING.

## CLAMPING FORCE CHART

ORDER NO.	SCALE KN				
	4	3	2	1	0
VQC-100	-	30KN	21KN	12KN	6KN
VQC-125	-	40KN	28KN	16KN	8KN
VQC-160	60KN	46KN	32KN	18KN	10KN
VQC-160L	60KN	46KN	32KN	18KN	10KN
VQC-200L	60KN	46KN	32KN	18KN	10KN

**OPTIONAL:** Soft jaw for different shape workpiece FJ & MJ can for cutting

FJ

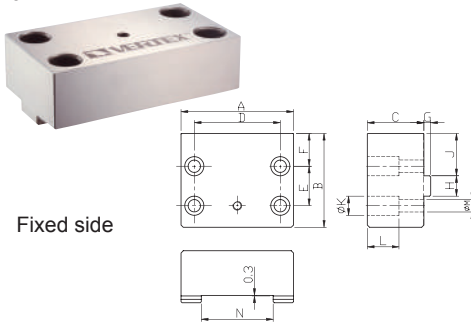

## SOFT FIXED JAW

ORDER NO.	A	B	C	D	E	F	G	H	J	K	L	M	N	CODE NO.
VQC-100FJ	99.5	73	50	76	35	19	6	18	27.5	17	26	11	55	4005-013
VQC-125FJ	124.5	91	60	88	45	29.5	8	24	40	19	33.5	13	63	4005-014
VQC-160FJ	159.5	102	60	124	50	34	9	28	45	22	30	15	84	4005-015
VQC-160L-FJ	159.5	102	60	124	50	34	9	28	45	22	30	15	84	4005-016
VQC-200L-FJ	200	122	75	140	62	40	9	28	57	25	37	17	100	4005-016A

MJ

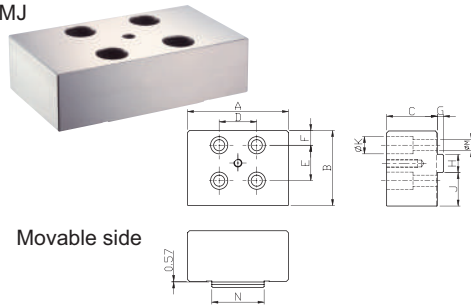

## SOFT MOVEABLE JAW

ORDER NO.	A	B	C	D	E	F	G	H	J	K	L	M	N	CODE NO.
VQC-100MJ	99.5	64	50	37	35	14.5	6	18	23	17	26	11	51.5	4005-017A
VQC-125MJ	124.5	87	60	35	42	29	8	24	38	19	33.5	13	59.5	4005-017
VQC-160MJ	159.5	102	60	56	50	34	9	28	45	22	30	15	80.5	4005-018
VQC-160L-MJ	159.5	102	60	56	50	34	9	28	45	22	30	15	80.5	4005-019
VQC-200L-MJ	200	117	75	62	59	39	9	28	54.5	25	37	17	95	4005-019A



VICE JAWS CAN TURN 180° FOR YOUR REQUIREMENT.

**OPTIONAL:** Hard jaw for thin type workpiece

FJL

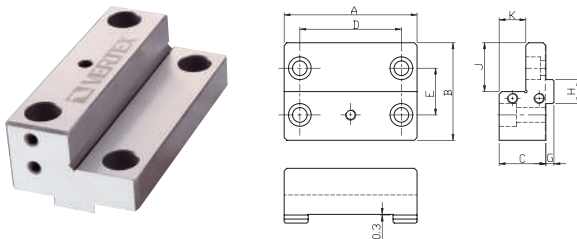

## L TYPE FIXED JAW

ORDER NO.	A	B	C	D	E	G	H	J	K	CODE NO.
VQC-100FJL	99.5	73	35	76	35	6	18	36.5	20	4005-010B
VQC-125FJL	124.5	78	40	88	45	8	24	39	20	4005-008A
VQC-160FJL	159.5	86	50	124	50	9	28	43	25	4005-009
VQC-160L-FJL	159.5	86	50	124	50	9	28	43	25	4005-010
VQC-200L-FJL	200	102	70	140	62	9	28	51	35	4005-010A

MJL

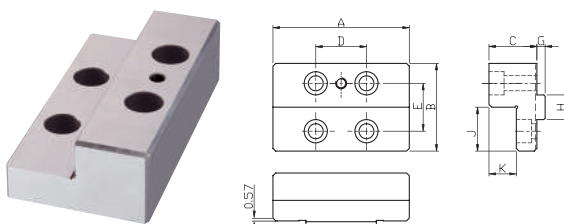

## L TYPE MOVEABLE JAW

ORDER NO.	A	B	C	D	E	G	H	J	K	CODE NO.
VQC-100MJL	99.5	64	35	37	35	6	18	32	20	4005-013B
VQC-125MJL	124.5	74	40	35	42	8	24	37	20	4005-011
VQC-160MJL	159.5	86	50	56	50	9	28	43	25	4005-012
VQC-160L-MJL	159.5	86	50	56	50	9	28	43	25	4005-013
VQC-200L-MJL	200	98	70	62	59	9	28	49	35	4005-013A

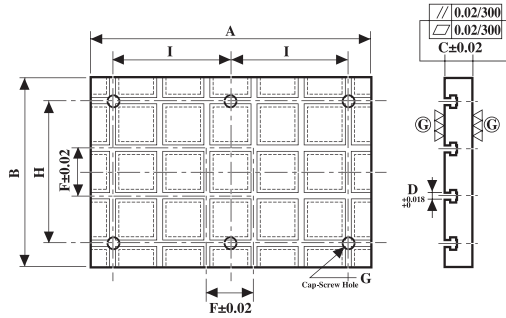
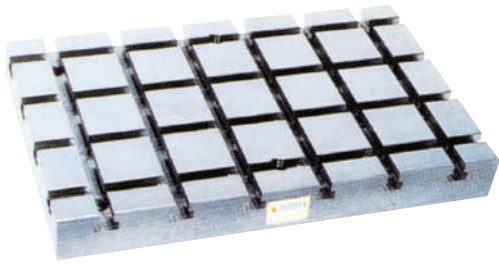

## SUB TABLE T-SLOT TYPE

Sub-plates used on vertical machining centers and larger milling machines.

They protect the surface of machine table, and provide larger space for setting workpieces and minimize loss of operating time of expensive machine tools.

Material: Close grained cast iron, Annealed  
Finish: Top and bottom ground

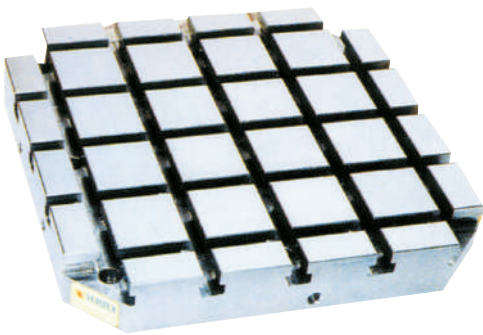

Unit:mm

ORDER NO.	A	B	C(±0.02)	D	E	F(±0.02)	G	kg	CODE NO.
TBP-6040	600	400	60	14	50	100	Ø18	120	4006-001
TBP-6050	600	500	60	14	50	100	Ø18	150	4006-002
TBP-6060	600	600	60	14	50	100	Ø18	179	4006-003
TBP-8040	800	400	60	14	50	100	Ø18	160	4006-004
TBP-9045	900	450	60	14	50	100	Ø18	204	4006-005
TBP-10050	1000	500	60	14	50	100	Ø18	248	4006-006
TBP-6040D	600	400	75	18	50	100	Ø18	100	4006-007
TBP-6050D	600	500	75	18	50	100	Ø18	125	4006-008
TBP-6060D	600	600	75	18	50	100	Ø18	149	4006-009
TBP-8040D	800	400	75	18	50	100	Ø18	133	4006-010
TBP-9045D	900	450	75	18	50	100	Ø18	169	4006-011
TBP-10050D	1000	500	75	18	50	100	Ø18	207	4006-012

Special dimension's order welcome.

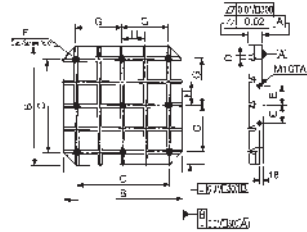

## SQUARE TYPE

Unit:mm

ORDER NO.	A(±0.02)	B	C	D(H7)	E	F	G(±0.02)	H(±0.02)	kg	CODE NO
SBP-4040	60	400	320	14	55	Ø18	160	80	56	4006-020
SBP-5050	60	500	400	14	75	Ø18	200	100	90	4006-021
SBP-6363	60	630	500	14	100	Ø18	250	125	149	4006-022
SBP-8080	60	800	640	14	135	Ø18	320	160	230	4006-023
SBP-4040A	75	400	320	18	55	Ø18	160	80	85	4006-024
SBP-5050A	75	500	400	18	75	Ø18	200	100	118	4006-025
SBP-6363A	75	630	500	18	100	Ø18	250	125	195	4006-026
SBP-8080A	75	800	640	18	135	Ø18	320	160	298	4006-027

Special dimension's order welcome.

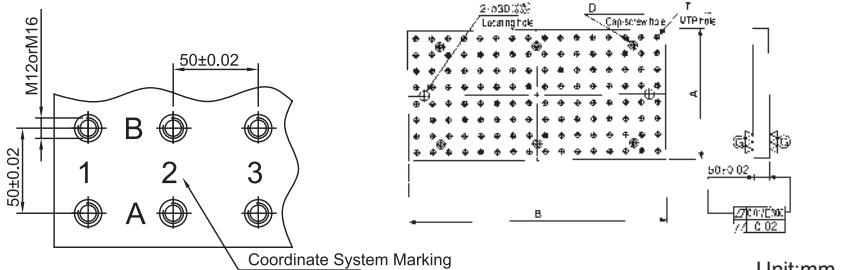
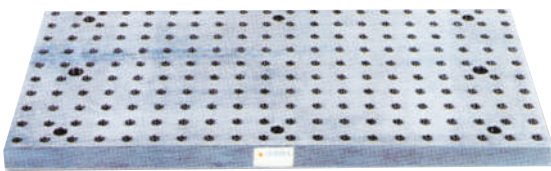

## SUB TABLE THERAD TYPE

Unit:mm

ORDER NO.	A	B	D	T		NO. OF MTP HOSE	KGS	CODE NO.
				(F7)	TAP			
HBP-4060	400	600	Ø18	Ø12	M12	96	90	4006-030
HBP-5060	500	600	Ø18	Ø12	M12	120	112	4006-031
HBP-6060	600	600	Ø18	Ø12	M12	144	134	4006-032
HBP-4080	400	800	Ø18	Ø12	M12	128	119	4006-033
HBP-4590	450	900	Ø18	Ø12	M12	162	151	4006-034
HBP-50100	500	1000	Ø18	Ø12	M12	200	187	4006-035
HBP-4060T	400	600	Ø18	Ø16	M16	96	87	4006-036
HBP-5060T	500	600	Ø18	Ø16	M16	120	108	4006-037
HBP-6060T	600	600	Ø18	Ø16	M16	144	129	4006-038
HBP-4080T	400	800	Ø18	Ø16	M16	128	115	4006-039
HBP-4590T	450	900	Ø18	Ø16	M16	162	146	4006-040
HBP-50100T	500	1000	Ø18	Ø16	M16	200	180	4006-041

Special dimension's order welcome.



# M/C Angle Plate 90°



● COLOR MAY VARY

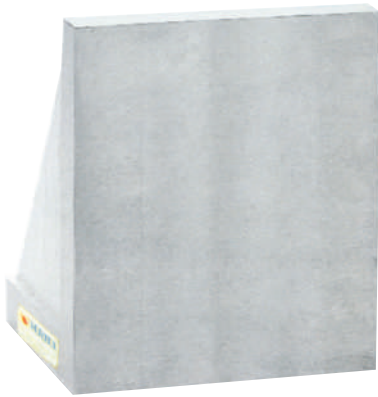

M12

M12 LOCATION HOLE

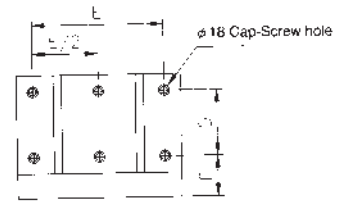
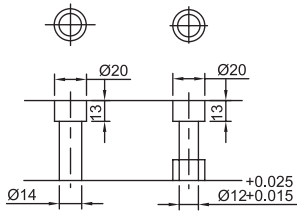

M16

M16 LOCATION HOLE

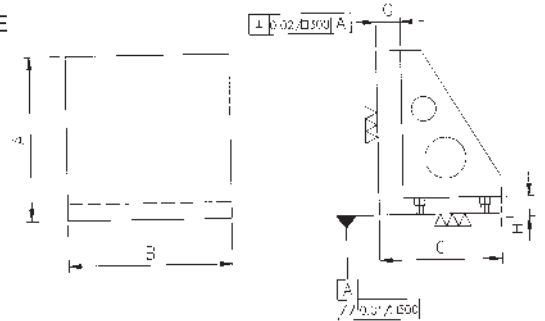
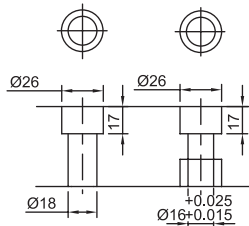

- Material/Finish:  
Material:FC30(JIS)/GG30(DIN)  
Heat treated (Normalized)
- Application:Good for horizontal M/C
- eye bolt included.

ORDER NO.	A	B	C	D	E	F	G	H	kgs	CODE NO.
BP20-30	300	300	220	100	250	90	40	30	52	4007-001
BP20-40	400	400	280	160	320	90	40	30	90	4007-002
BP20-50	500	500	350	200	400	90	50	35	175	4007-003
BP20-60	630	630	450	250	500	100	50	40	305	4007-004
BP20-80	800	800	550	302	640	115	50	45	480	4007-005



# M/C Angle Plate 90°

T-SLOT TYPE

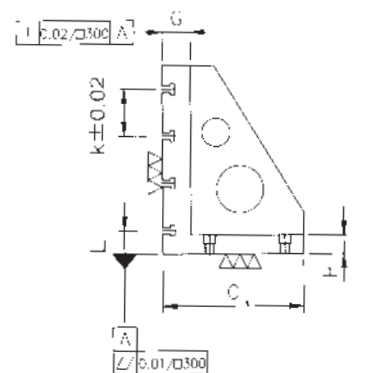
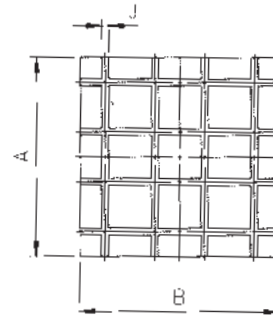
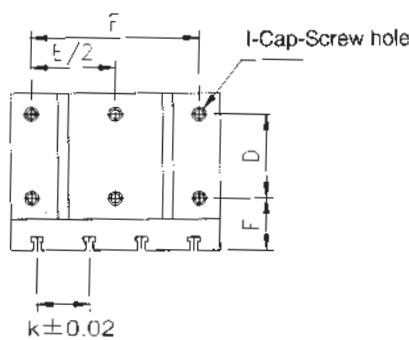

● COLOR MAY VARY

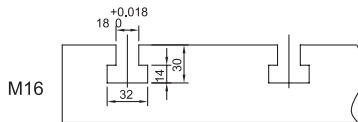
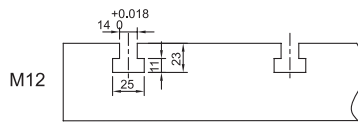

ORDER NO.	A	B	C	D	E	F	G	H	I	J	K (+0.02)	L	KGS	CODE NO.
BP22-30	300	300	220	100	250	90	60	30	Ø18	14	100	50	62.5	4007-010
BP22-40	400	400	280	160	320	90	60	30	Ø18	14	100	50	114.2	4007-011
BP22-50	500	500	350	200	400	90	60	35	Ø18	14	100	50	184	4007-012
BP22-60	630	630	450	250	500	100	60	40	Ø18	14	125	65	316	4007-013
BP22-80	800	800	550	320	640	115	75	45	Ø18	14	150	100	577	4007-014
BP22-830	300	300	220	100	250	90	60	30	Ø18	18	100	50	59.2	4007-015
BP22-840	400	400	300	160	320	90	60	30	Ø18	18	100	50	111.2	4007-016
BP22-850	500	500	350	200	400	90	60	35	Ø18	18	100	50	184	4007-017
BP22-860	630	630	450	250	500	100	65	40	Ø18	18	125	65	304	4007-018



- Material/Finish:  
Material:FC30(JIS)/GG30(DIN)  
Heat treated (Normalized)
- Application:Good for horizontal M/C
- Features:Free to finish an actual required hole pattern for your special jig.
- eye bolt included.
- COLOR MAY VARY

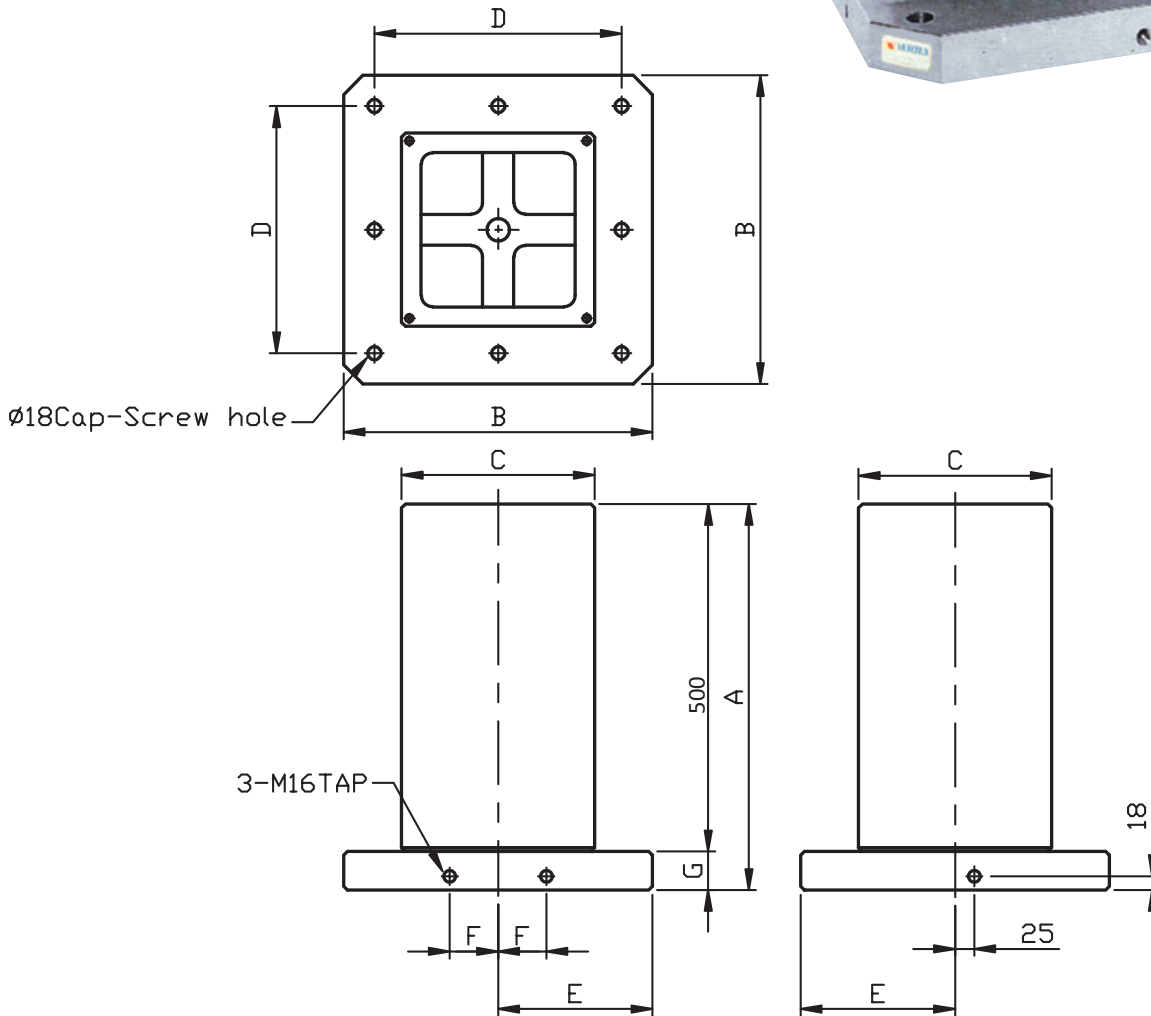

## SPECIAL DESIGN WELCOM

ORDER NO.	A	B	C	D	E	F	G	NO.of Mounting holes	kg	CODE NO.
BP07-10	500	400	250	320	200	55	50	4	175	4007-020
BP07-20	600	500	300	400	250	75	50	8	240	4007-021
BP07-30	700	630	350	500	315	100	50	8	390	4007-022
BP07-40	800	800	500	640	400	135	50	8	745	4007-023



# Angular Hollow Block 45°



● COLOR MAY VARY

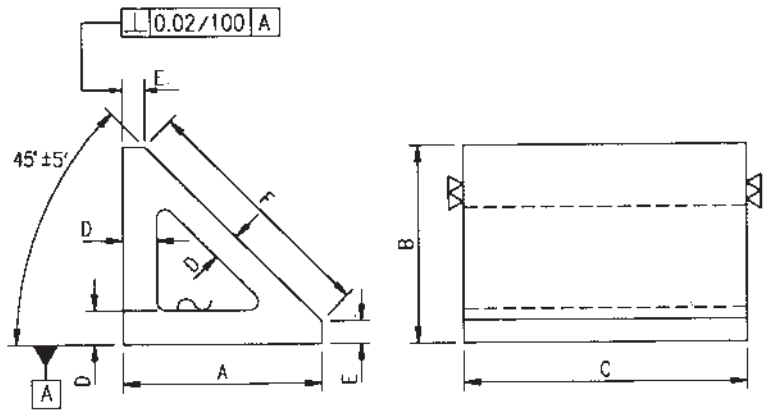
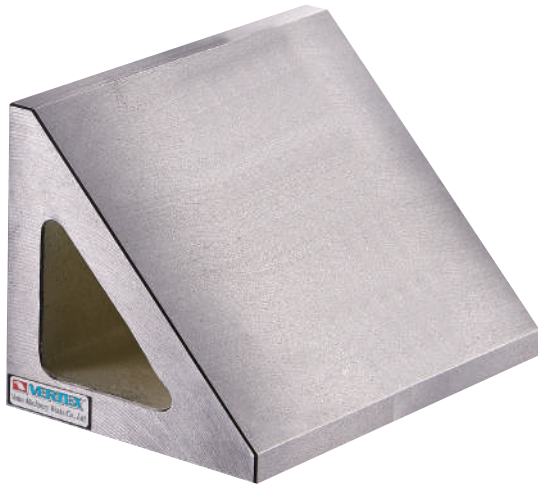

**Material:** Cast Iron  
 FC-300  
 GG-30

ORDER NO.	A	B	C	D	E	F	kgs	CODE NO.
BC45-15	100	100	150	14	10	127	4.5	4007-030
BC45-30	100	100	300	14	10	127	8.8	4007-031
BC45-151	200	200	150	22	20	255	15.0	4007-032
BC45-301	200	200	300	22	20	255	29.0	4007-033



# Angular Hollow Block 30°

● COLOR MAY VARY

T-SLOT TYPE

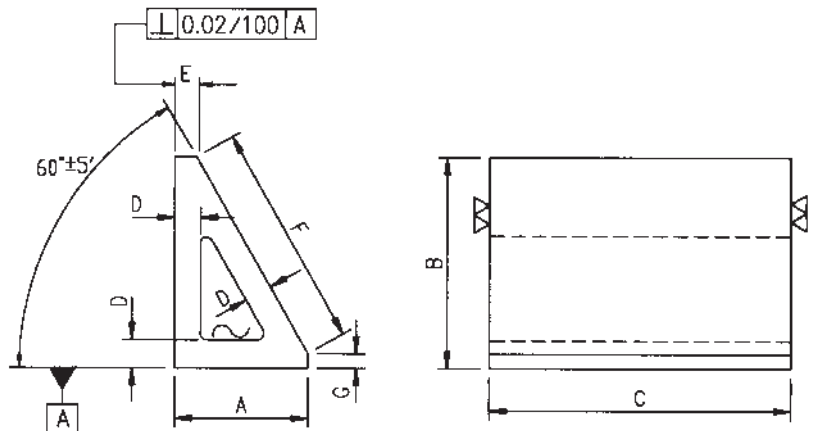
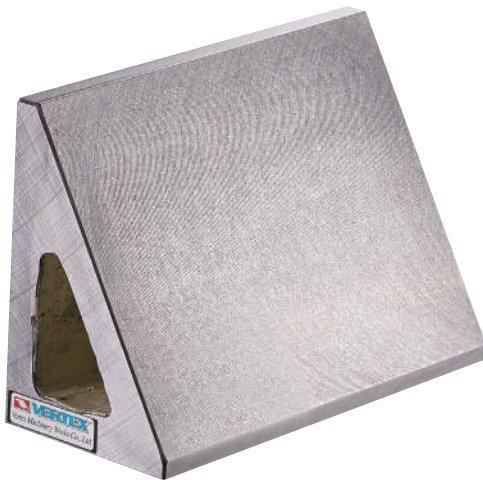

**Material:** Cast Iron  
 FC-300  
 GG-30

ORDER NO.	A	B	C	D	E	F	G	kgs	CODE NO.
BC30-15	63	100	150	12	9	108	6	3.0	4007-040
BC30-30	63	100	300	12	9	108	6	6.0	4007-041
BC30-151	125	200	150	20	14	222	8	9.5	4007-042
BC30-301	125	200	300	20	14	222	8	19.0	4007-043

ANGULAR HOLLOW BLOCK



# Flexible Line Up Vice



STANDARD STYLE

4 POSITION FOR EACH ITEM.

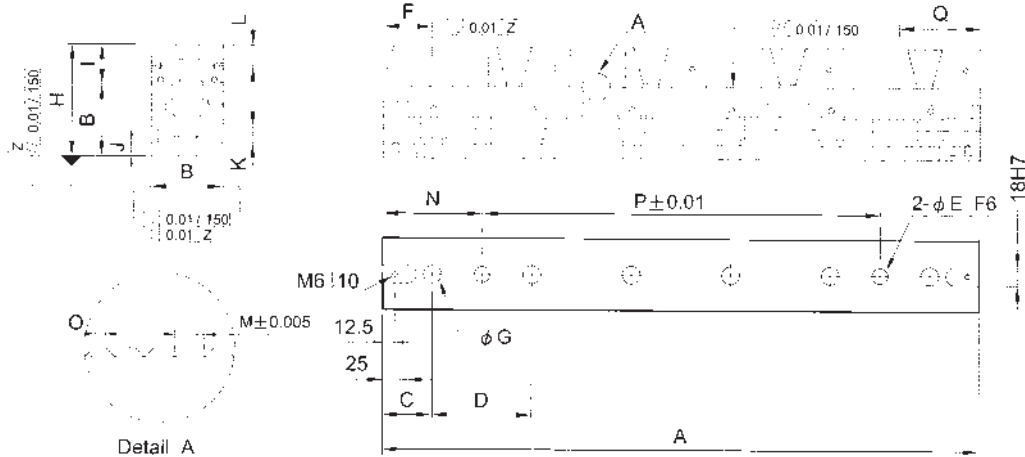

ORDER NO.	A	B±0.01	C	D	E	F	G	H	I	J	K	L	M	N	O	P	Q	KG	CODE NO.
VFS-5030	300	50	30	80	12	36	14	75	24.8	10	12	12.5	1.5	70	0.5	160	60	6.5	4007-050
VFS-5030G			50	100										100		4007-051			
VFS-5040	400	50	40	80	12	36	14	75	24.8	10	12	12.5	1.5	80	0.5	240	60	8.5	4007-052
VFS-5040G			50	100										100		200			4007-053
VFS-5050	500	50	50	80	12	36	14	75	24.8	10	12	12.5	1.5	90	0.5	320	60	10	4007-054
VFS-5050G				100										300		4007-055			
VFS-5060	600	50	60	80	12	36	14	75	24.8	10	12	12.5	1.5	100	0.5	400	60	11.5	4007-056
VFS-5060G			50	100										4007-057					
VFS-5070	700	50	70	80	12	36	14	75	24.8	10	12	12.5	1.5	110	0.5	480	60	13	4007-058
VFS-5070G			50	100										500		4007-059			
VFS-7240	400	72	50	100	16	48	18	110	39.7	14	16	21.3	2.0	100	0.7	200	82	19	4007-060
VFS-7250	500	72	50	100	16	48	18	110	39.7	14	16	21.3	2.0	100	0.7	300	82	25	4007-061
VFS-7260	600	72	50	100	16	48	18	110	39.7	14	16	21.3	2.0	100	0.7	400	82	27	4007-062
VFS-7270	700	72	50	100	16	48	18	110	39.7	14	16	21.3	2.0	100	0.7	500	82	30	4007-063

Material : tool steel

Hardness : over HRC55

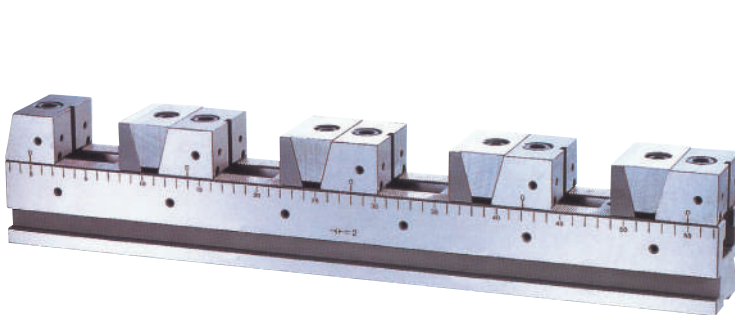





one workpieces

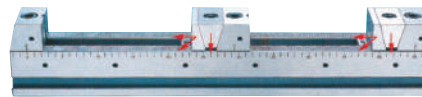

two workpieces

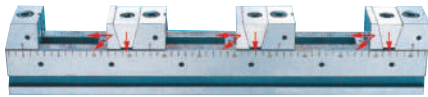

three workpieces

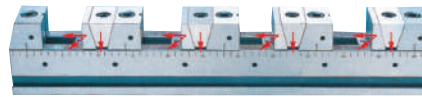

four workpieces

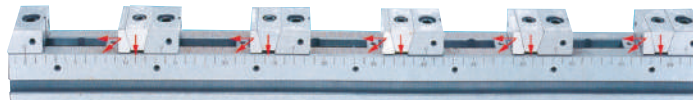

five workpieces

ONE WAY FIX JAW TYPE

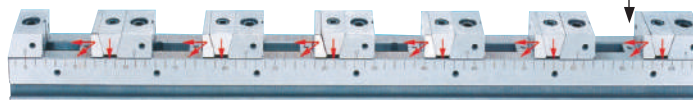

six workpieces

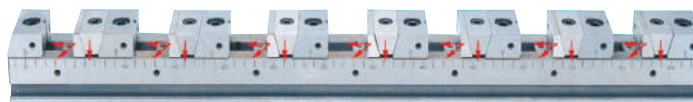

seven workpieces

## Maximum width of the workpieces can be clamped

ORDER NO.	One workpiece	Two workpieces	Three workpieces	Four workpieces
VFS-5030	203	71	27	--
VFS-5040	303	121	60	30
VFS-5050	403	171	94	55
VFS-5060	503	221	127	80
VFS-5070	603	271	160	105
VFS-7240	269	93	35	--
VFS-7250	369	143	68	30
VFS-7260	469	193	101	55
VFS-7270	569	243	135	80

ORDER NO.	Five workpiece	Six workpiece	Seven workpiece	Eight workpiece	Nine workpiece
VFS-5030	--	--	--	--	--
VFS-5040	--	--	--	--	--
VFS-5050	32	16	--	--	--
VFS-5060	52	33	20	--	--
VFS-5070	72	50	34	22	13
VFS-7240	--	--	--	--	--
VFS-7250	--	--	--	--	--
VFS-7260	28	--	--	--	--
VFS-7270	48	26	--	--	--

FLEXIBLE LINE UP VICE

# Flexible Line UP Vice



STANDARD STYLE  
4 POSITION FOR EACH ITEM.

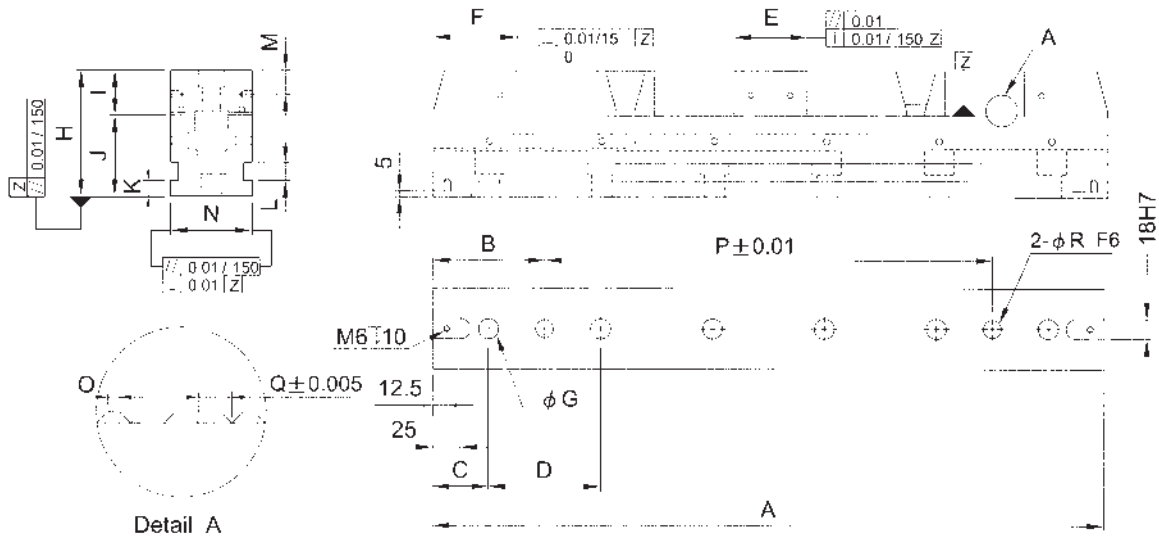

ORDER NO.	A	B	C	D	E	F	G	H	I	J	K	L	M	N	O	P	Q	R	KG	CODE NO.
VFL-5030	300	70	30	80	44	50	14	75	24.8	50	10	12	12.5	50	0.5	160	1.5	12	7	4007-080
VFL-5030G		100	50	100												100				4007-081
VFL-5040	400	80	40	80	44	50	14	75	24.8	50	10	12	12.5	50	0.5	240	1.5	12	7.6	4007-082
VFL-5040G		100	50	100												200				4007-083
VFL-5050	500	90	50	80	44	50	14	75	24.8	50	10	12	12.5	50	0.5	320	1.5	12	9	4007-084
VFL-5050G		100	50	100												300				4007-085
VFL-5060	600	100	60	80	44	50	14	75	24.8	55	10	12	12.5	50	0.5	400	1.5	12	11	4007-086
VFL-5060G			50	100																4007-087
VFL-5070	700	110	70	80	44	50	14	75	24.8	50	10	12	12.5	50	0.5	480	1.5	12	12	4007-088
VFL-5070G		100	50	100												500				4007-089
VFL-7240	400	100	50	100	65	75	18	110	39.7	72	14	16	21.3	72	0.7	200	2.0	16	19	4007-090
VFL-7250	500	100	50	100	65	75	18	110	39.7	72	14	16	21.3	72	0.7	300	2.0	16	27	4007-091
VFL-7260	600	100	50	100	65	75	18	110	39.7	72	14	16	21.3	72	0.7	400	2.0	16	25	4007-092
VFL-7270	700	100	50	100	65	75	18	110	39.7	72	14	16	21.3	72	0.7	500	2.0	16	27.5	4007-093

Material: tool steel  
Hardness: over HRC55

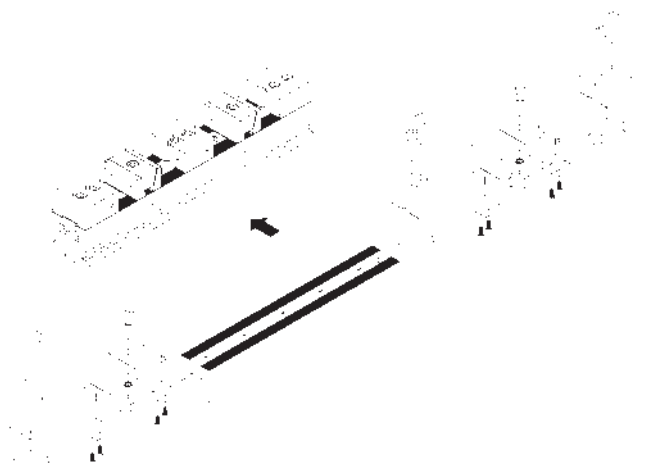
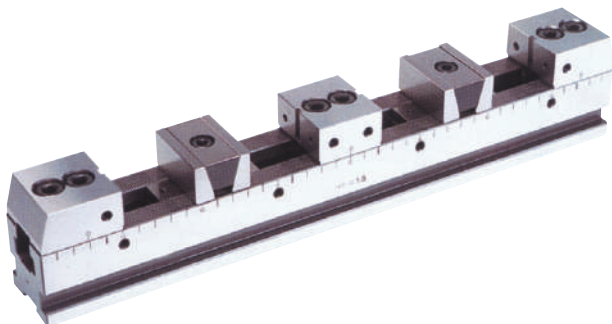



one workpieces

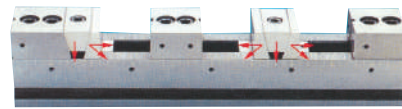

three workpieces

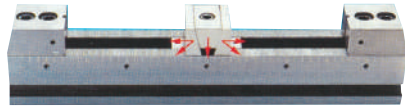

two workpieces

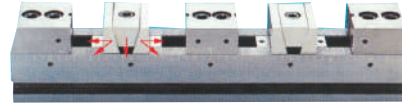

four workpieces



five workpieces

TOW WAY FIX JAW TYPE



six workpieces

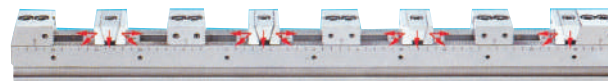

seven workpieces

FLEXIBLE LINE UP VICE

## Maximum width of the workpieces can be clamped

ORDER NO.	One workpiece	Two workpieces	Three workpieces	Four workpieces	Five workpieces
VFL-5030	176	82	32	21	--
VFL-5040	276	132	65	46	23
VFL-5050	376	182	98	71	43
VFL-5060	476	232	132	96	63
VFL-7240	217	100	33	20	--
VFL-7250	317	150	65	45	16
VFL-7260	417	200	100	70	36
VFL-7270	517	250	133	95	56

ORDER NO.	Six workpiece	Seven workpieces	Eight workpieces	Nine workpieces	Ten workpieces	Eleven workpieces
VFL-5030	--	--	--	--	--	--
VFL-5040	17	--	--	--	--	--
VFL-5050	34	19	15	--	--	--
VFL-5060	50	33	28	17	14	--
VFL-7240	--	--	--	--	--	--
VFL-7250	--	--	--	--	--	--
VFL-7260	27	--	--	--	--	--
VFL-7270	44	23	18	--	--	--



**NEW**

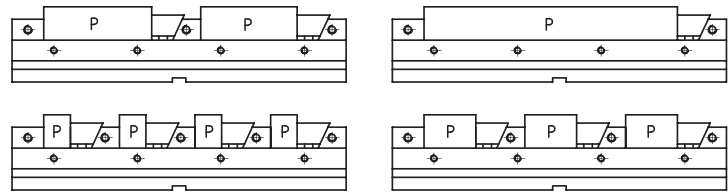
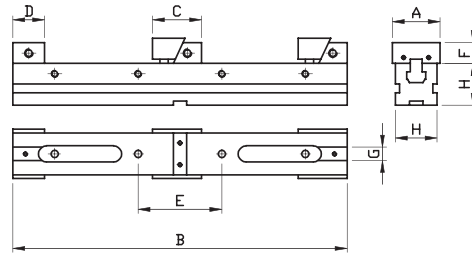
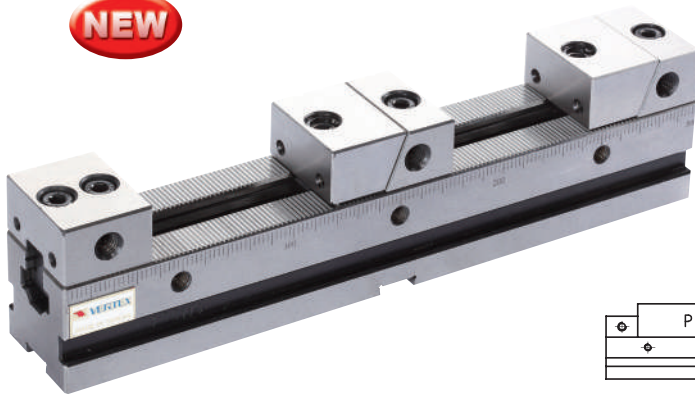

ORDER NO.	B	H	A	C	D	E	F	G	1P	2P	3P	4P	KGS	SCREW	CODE NO.
VFN-6030	300	50	59	55~58	38	100	25	16	208	75	30	8	7	M8	4007-131
VFN-6040	400								305	125	64	33	9		4007-132
VFN-6050	500								408	175	96	58	10		4007-133
VFN-6060	600								508	225	129	83	12		4007-134
VFN-6070	700								608	275	162	108	14		4007-135
VFN-8540	400	75	84	70~75	50	40	40	16	275	100	41	12	22	M10	4007-136
VFN-8550	500								375	150	75	37	26		4007-137
VFN-8560	600								475	200	108	62	30		4007-138
VFN-8570	700								575	250	141	87	33		4007-139
VFN-8580	800								675	300	174	102	37		4007-140

### Maximum width of the workpieces can be clamped

ORDER NO.	One workpiece	Two workpieces	Three workpieces	Four workpieces
	1P	2P	3P	4P
VFN-6030	208	75	30	8
VFN-6040	305	125	64	33
VFN-6050	408	175	96	58
VFN-6060	508	225	129	83
VFN-6070	608	275	162	108
VFN-8540	275	100	41	12
VFN-8550	375	150	75	37
VFN-8560	475	200	108	62
VFN-8570	575	250	141	87
VFN-8580	675	300	174	102